

### STÓŁY KONFERENCYJNE Z PRZEWIESZENIEM

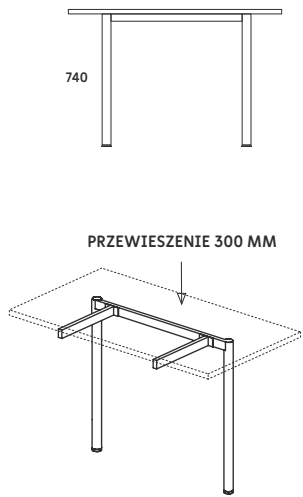

STELAŻ TYPU: DUO-C  
PROFIL PIONU: OKRĄGŁY Ø40 MM  
PROFIL ŁĄCZNY: 60X20 MM  
REGULACJA POZIOMUJĄCA: +/- 10 MM

#### STÓŁ KONFERENCYJNY DUO-C

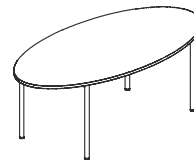
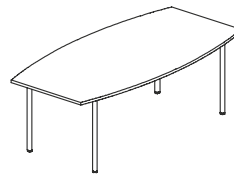
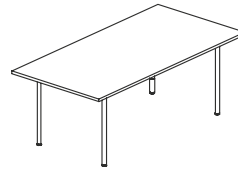
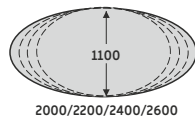
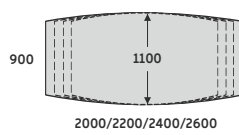
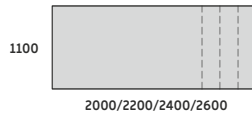

#### DUO-C

CD-SKP01 2000x1100x740  
CD-SKP02 2200x1100x740  
CD-SKP03 2400x1100x740  
CD-SKP04 2600x1100x740

#### DUO-C

CD-SKB01 2000x900/1100x740  
CD-SKB02 2200x900/1100x740  
CD-SKB03 2400x900/1100x740  
CD-SKB04 2600x900/1100x740

#### DUO-C

CD-SKE01 2000x1100x740  
CD-SKE02 2200x1100x740  
CD-SKE03 2400x1100x740  
CD-SKE04 2600x1100x740

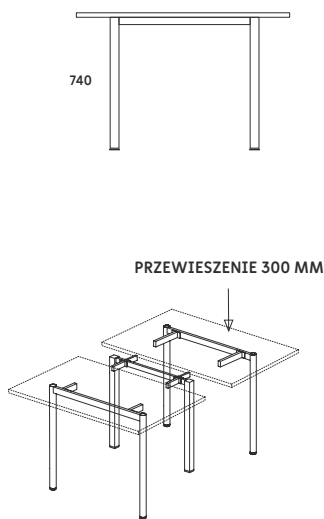

STELAŻ TYPU: DUO-C  
PROFIL PIONU: OKRĄGŁY Ø40 MM  
PROFIL ŁĄCZNY: 60X20 MM  
PROFIL NOGI ŚRODKOWEJ: 40X40 MM  
REGULACJA POZIOMUJĄCA: +/- 10 MM

#### STÓŁ KONFERENCYJNY DUO-C

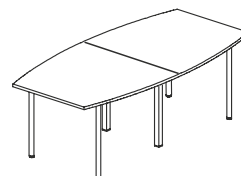
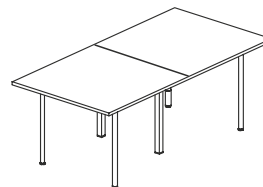
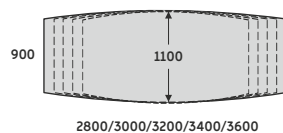
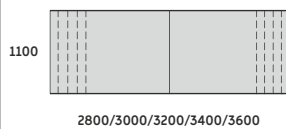

#### DUO-C

CD-SKP05 2800x1100x740  
CD-SKP06 3000x1100x740  
CD-SKP07 3200x1100x740  
CD-SKP08 3400x1100x740  
CD-SKP09 3600x1100x740

#### DUO-C

CD-SKB05 2800x900/1100x740  
CD-SKB06 3000x900/1100x740  
CD-SKB07 3200x900/1100x740  
CD-SKB08 3400x900/1100x740  
CD-SKB09 3600x900/1100x740

#### MODUŁ ROZSZERZAJĄCY

SR-P01 1010x1100x740  
SR-P02 1210x1100x740  
SR-P03 1410x1100x740  
SR-P04 1610x1100x740

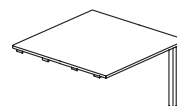

### STÓŁY KONFERENCYJNE BEZ PRZEWIESZENIA



#### STÓŁ KONFERENCYJNY KWADRATOWY DUO-C

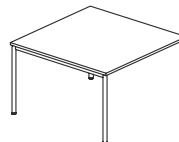
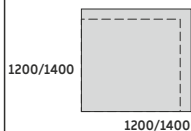

**DUO-C**  
CD-SKP1201 1200x1200x740  
CD-SKP1402 1400x1400x740

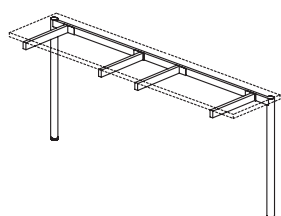

#### STÓŁ KONFERENCYJNY PROSTOKĄTNY DUO-C

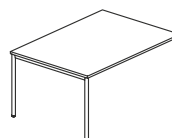
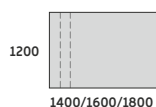

**DUO-C**  
CD-SKP1202 1400x1200x740  
CD-SKP1203 1600x1200x740  
CD-SKP1204 1800x1200x740

STELAŻ TYPU: DUO-C  
PROFIL: OKRĄGŁY Ø40 MM  
PROFIL ŁĄCZNY: 40X20 MM  
REGULACJA POZIOMUJĄCA: +/- 10 MM

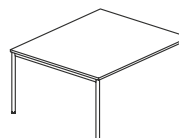
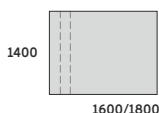

**DUO-C**  
CD-SKP1403 1600x1400x740  
CD-SKP1404 1800x1400x740



#### STÓŁ KONFERENCYJNY KWADRATOWY DUO-C Z PRZEPUSTEM KABLOWYM

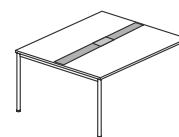
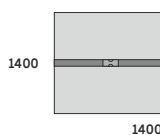

**DUO-C**  
CD-SKP1402/W 1400x1400x740  
CD-SKP1603/W 1600x1600x740

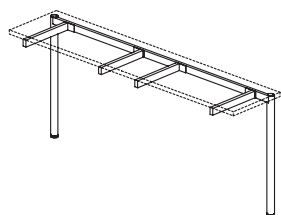

#### STÓŁ KONFERENCYJNY PROSTOKĄTNY DUO-C Z PRZEPUSTEM KABLOWYM

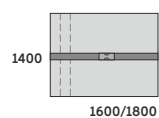

**DUO-C**  
CD-SKP1403/W 1600x1400x740  
CD-SKP1404/W 1800x1400x740

STELAŻ TYPU: DUO-C  
PRZEPUST KABLOWY  
PROFIL: OKRĄGŁY Ø40 MM  
PROFIL ŁĄCZNY: 40X20 MM  
REGULACJA POZIOMUJĄCA: +/- 10 MM

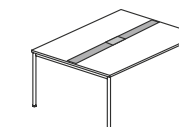
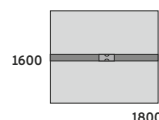

**DUO-C**  
CD-SKP1604/W 1800x1600x740

## STOŁY KONFERENCYJNE BEZ PRZEWIESZENIA

### STÓŁ KONFERENCYJNY PROSTOKĄTNY ŁĄCZONE DUO-C



740

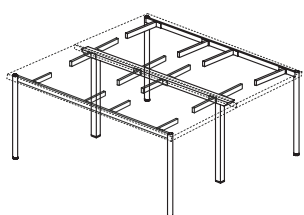

STELAŻ TYPU: DUO-C  
PROFIL: OKRĄGŁY Ø40 MM  
PROFIL ŁĄCZNY: 40X20 MM  
PROFIL NOGI ŚRODKOWEJ: 40X40 MM  
REGULACJA POZIOMUJĄCA: +/- 10 MM

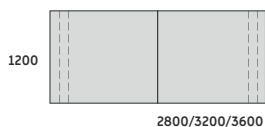

1200

2800/3200/3600

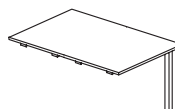
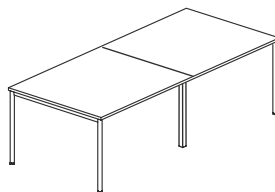

**DUO-C**  
CD-SKP1209 2800x1200x740  
CD-SKP1211 3200x1200x740  
CD-SKP1213 3600x1200x740

#### MODUŁ ROZSZERZAJĄCY

SR-B1201 1000x1200x740  
SR-B1202 1200x1200x740  
SR-B1203 1400x1200x740  
SR-B1204 1600x1200x740



1400

2800/3200/3600

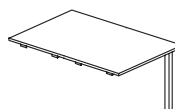
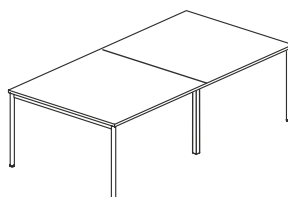

**DUO-C**  
CD-SKP1409 2800x1400x740  
CD-SKP1411 3200x1400x740  
CD-SKP1413 3600x1400x740

#### MODUŁ ROZSZERZAJĄCY

SR-B1401 1000x1400x740  
SR-B1402 1200x1400x740  
SR-B1403 1400x1400x740  
SR-B1404 1600x1400x740

### STÓŁ KONFERENCYJNY DUO-C Z PRZEPUSTEM KABLOWYM

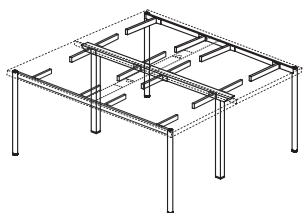

STELAŻ TYPU: DUO-C  
PRZEPUST KABLOWY  
PROFIL: OKRĄGŁY Ø40 MM  
PROFIL ŁĄCZNY: 40X20 MM  
PROFIL NOGI ŚRODKOWEJ: 40X40 MM  
REGULACJA POZIOMUJĄCA: +/- 10 MM

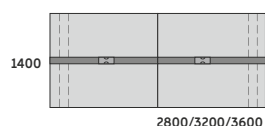

1400

2800/3200/3600

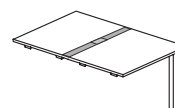
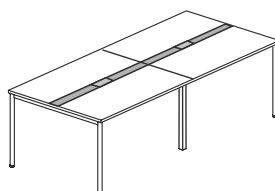

**DUO-C**  
CD-SKP1409/W 2800x1400x740  
CD-SKP1411/W 3200x1400x740  
CD-SKP1413/W 3600x1400x740

#### MODUŁ ROZSZERZAJĄCY

SR-B1401/W 1000x1400x740  
SR-B1402/W 1200x1400x740  
SR-B1403/W 1400x1400x740  
SR-B1404/W 1600x1400x740

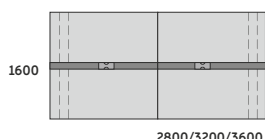

1600

2800/3200/3600

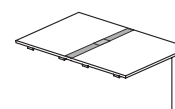
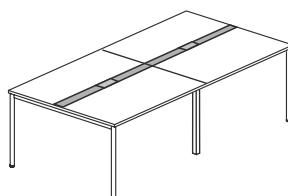

**DUO-C**  
CD-SKP1609/W 2800x1600x740  
CD-SKP1611/W 3200x1600x740  
CD-SKP1613/W 3600x1600x740

#### MODUŁ ROZSZERZAJĄCY

SR-B1601/W 1000x1600x740  
SR-B1602/W 1200x1600x740  
SR-B1603/W 1400x1600x740  
SR-B1604/W 1600x1600x740