

POLMARCO



e x e c u t i v e s



mono

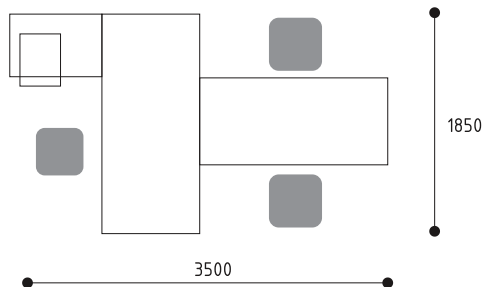

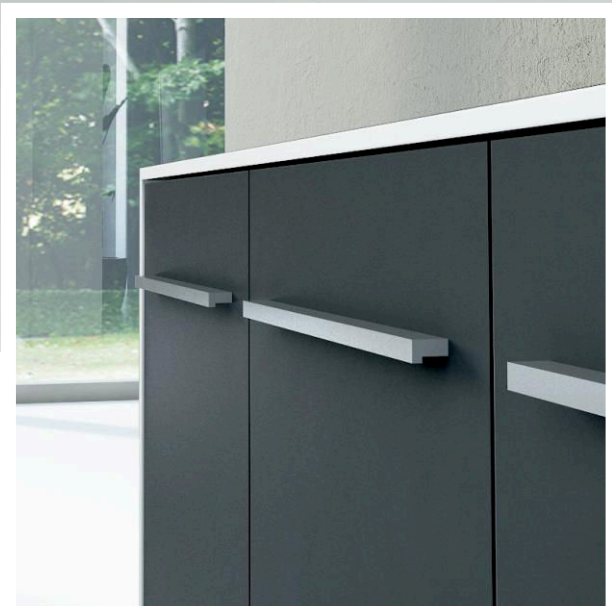

mono

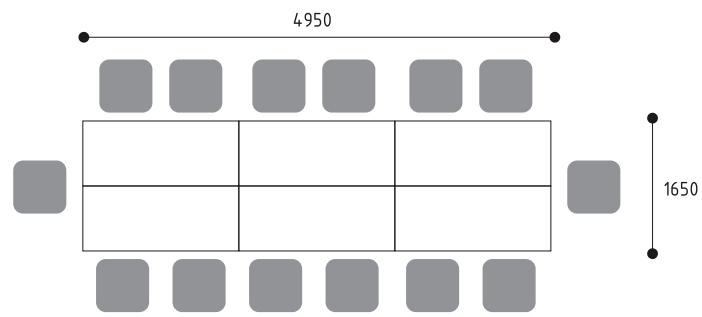





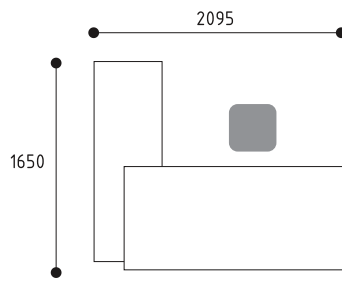

MONO



FUTURA

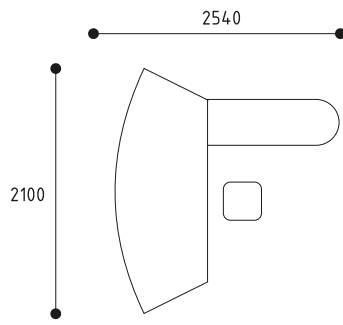







FUTURA

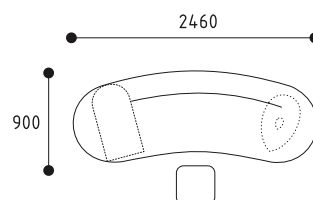

FUTURA

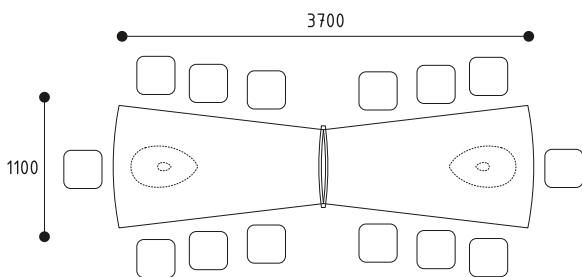





NEXT

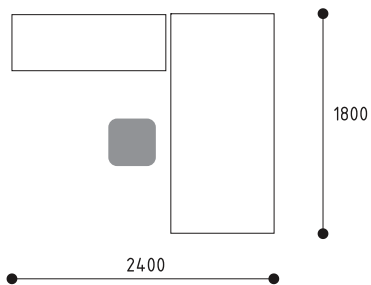



NEXT

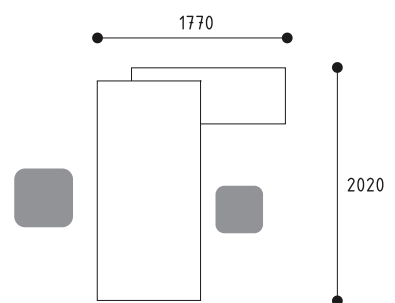
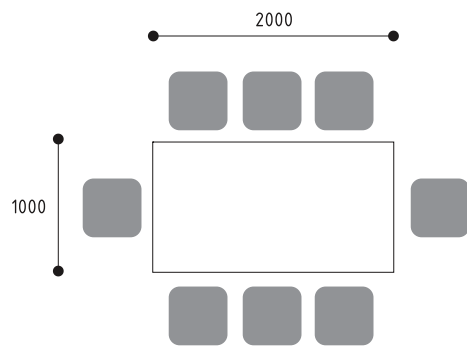



SPATHIO

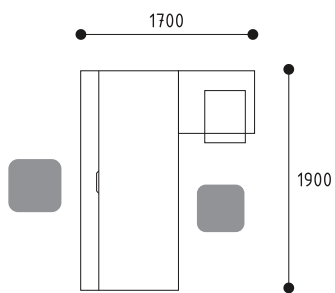



SPATHIO

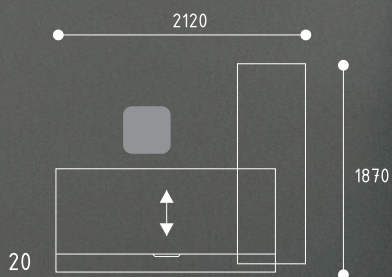
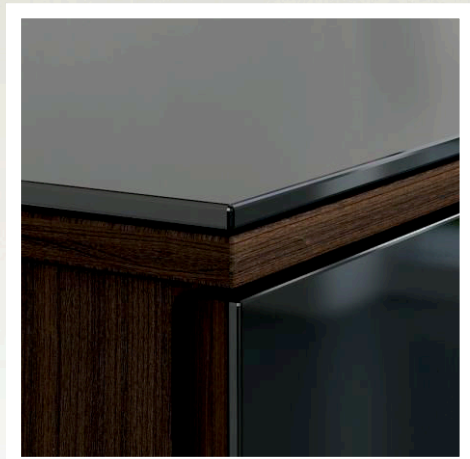

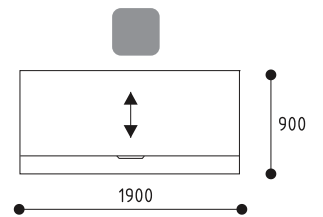
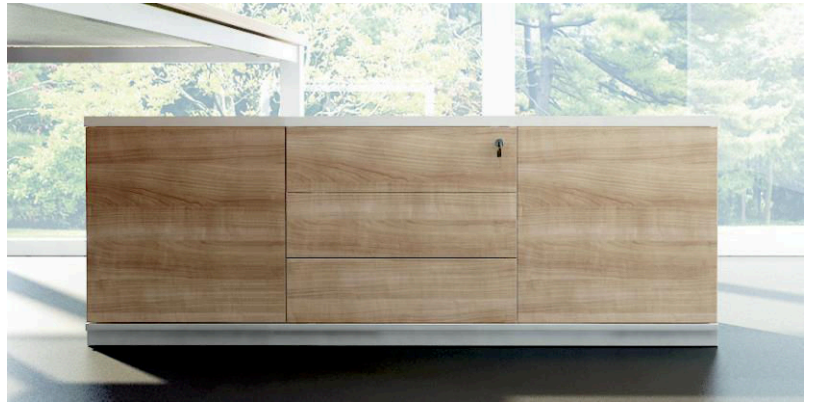



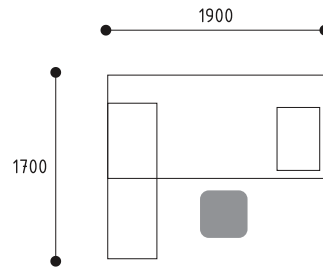

PRESTIGE



PRESTIGE

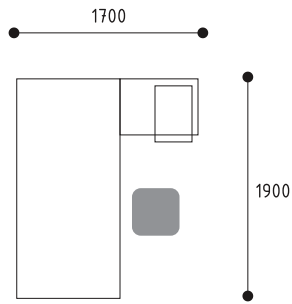

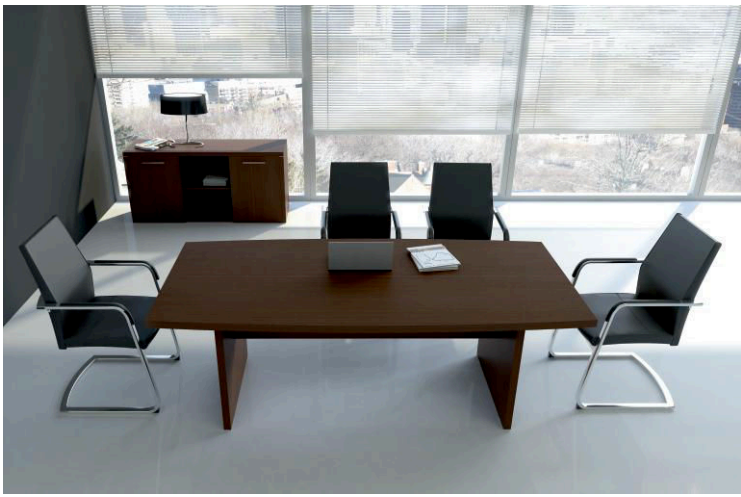

PRESTIGE

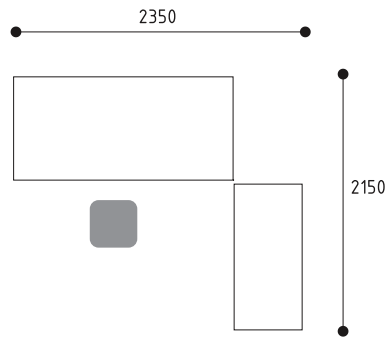



PRESTIGE

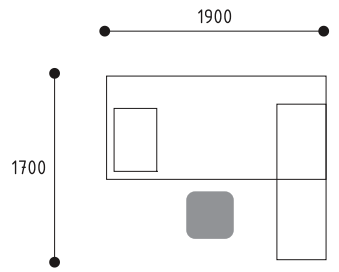

mono



MNB 01 1650x850 h740
MNB 02 1850x850 h740

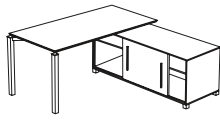

MNB/SP 01 1895x1650 h740
MNB/SP 02 2095x1650 h740

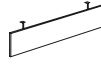

MNBL 01 1350x18 h350
MNBL 02 1550x18 h350

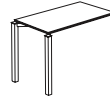

MND 1025x650 h740

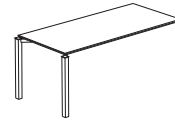

MNDK 1625x950 h740

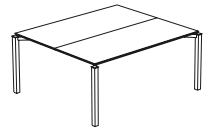

MNSK 1650x1650 h740

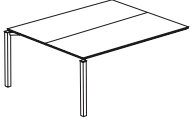

MNSKZ 1625x1650 h740

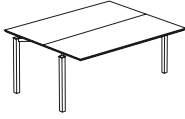

MNSKM 1600x1600 h740



MNSO 750x750 h550



MNKM 445x550 h575



MNKS 445x550 h550



MNKD 1100x450 h575

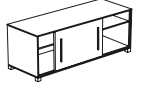

MNSP 1450x550 h550

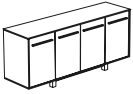

MN16D 1600x450 h700

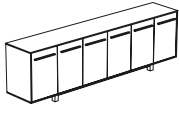

MN24D 2400x450 h700

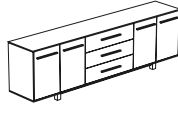

MN24S 2400x450 h700

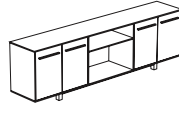

MN24R 2400x450 h700

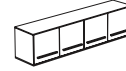

MNW16D 1600x350 h400

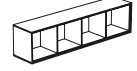

MNW16R 1600x350 h400

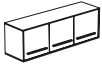

MNW12D 1200x350 h400

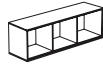

MNW12R 1200x350 h400

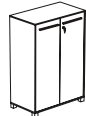

MN3D 800x450 h1140

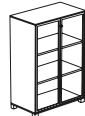

MN3S 800x450 h1140

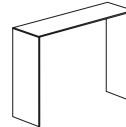

K30H8 K30H16 K30H24
K50H8 K50H16 K50H24

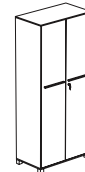

MN5D 800x450 h1845

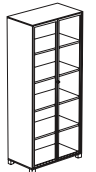

MN5S 800x450 h1845

FUTURA

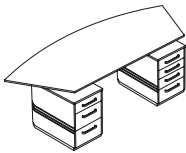

FTB2K 2540x950 h740

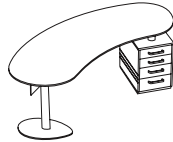

FTB1K 2460x900 h740

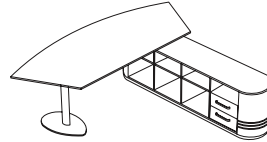

FTBP 2540x2100 h740

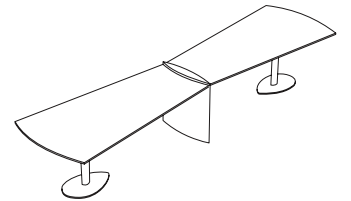

FTSK 3700x1100 h740

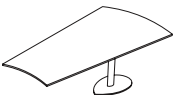

FTSM 1850x1100 h740



FTO 680x450 h600



FTOP 600x500 h600

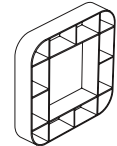

FTRW 1450x1450x300



FTS2D 1400x400 h760

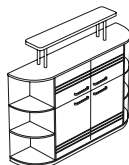

FTS3D 1700x400 h1450



FTU2D3S 1900x420 h1900

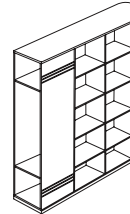

FTUSR 1900x420 h1900

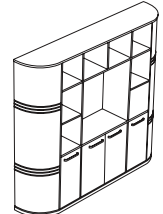

FTS2D3R 2050x400 h1900

SPATHIO



SPB 01 1600x800x740
SPB 02 1900x900x740

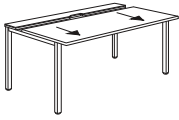

SPB+S 01 1600x800x740
SPB+S 02 1900x900x740

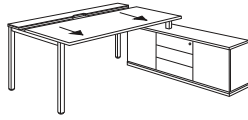

SPB+S/SPC 01 1820x1770x740
SPB+S/SPC 02 2120x1870x740

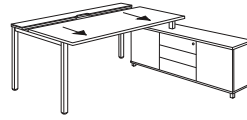

SPB+S/SPN 01 1820x1770x740
SPB+S/SPN 02 2120x1870x740

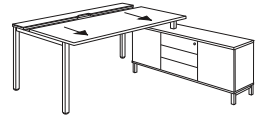

SPB+S/SPS 01 1820x1770x740
SPB+S/SPS 02 2120x1870x740

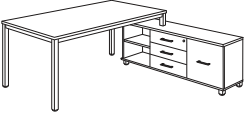

SPB/SP 01 1820x1770x740
SPB/SP 02 2120x1870x740



SPK 430x600x550



SPK 430x600x550

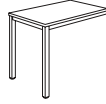

SPD 800x600x740

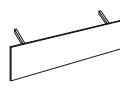

SPBL 01
SPBL 02



SPO 800x800x550



SPS 2000x1000x740



SP2R 800x420x810



SP2S 800x420x810



SP2D 800x420x810



SP3R 800x420x1168

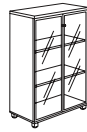

SP3S 800x420x1168



SP3D 800x420x1168

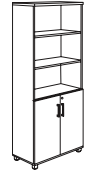

SP5DR 800x420x1875

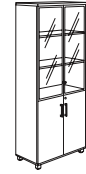

SP5DS 800x420x1875

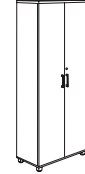

SP5D 800x420x1875



SPUB 600x420x1875



SP80R2 800x420x796

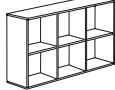

SP120R2 1200x420x796

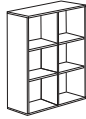

SP80R3 800x420x1194

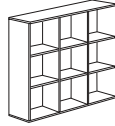

SP120R3 1200x420x1194

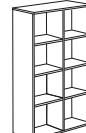

SP80R4 800x420x1590

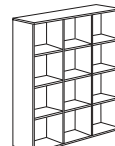

SP120R4 1200x420x1590

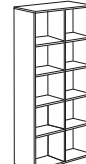

SP80R5 800x420x1988

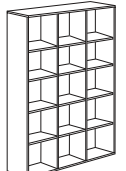

SP120R5 1200x420x1988

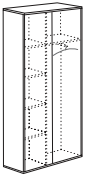

SP80U 800x420x1988



D10H 395x397
D10H+S 395x397



D20H 397x742



D30H 397x1189



D40H 397x1586



D50H 397x1983



TS8 800x420
TS12 1200x420
TS16 1600x420
TS24 2400x420



TS+S8 800x420
TS+S12 1200x420
TS+S16 1600x420



USC80 800x420x150
USC120 1200x420x150
USC160 1600x420x150



CM01 800x420x30
CM03 1200x420x30

NEXT



NEB-01 1600x800x740
NEB-02 1800x800x740



NEB/SP01 1820x1770x740
NEB/SP02 2020x1770x740



NED 800x600x740



NES-01 1600x1600x740
NES-02 2000x1000x740



NESO 700x700x550

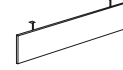

NEBL01
NEBL02



NESP 1450x450x660



NEK 430x550x575

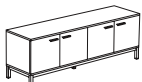

NE16K 1600x450x590

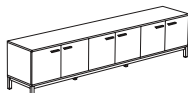

NE24K 2400x450x590



NE8R2 800x450x893

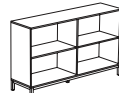

NE16R2 1600x450x893



NE24R2 2400x450x893



NEDP 800x18x704



NEDS 800x20x704

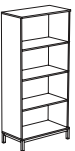

NE8R4 800x450x1600



NE16R4 1600x450x1600



NE24R4 2400x450x1600

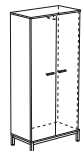

NE8U 800x450x1600

PRESTIGE

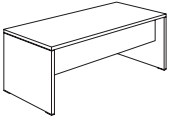

PRB-01 1600x900x740
PRB-02 1900x900x740

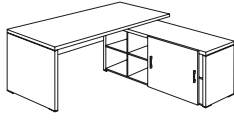

PRSB-01 1600x1700x740 L/P
PRSB-02 1900x1700x740 L/P

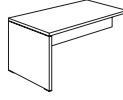

PRDK 1600x900x740



PRD 800x600x740 L/P

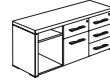

PRSP 1250x450x530 L/P



PRK 430x600x590

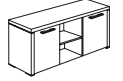

PRKM 1500x450x700

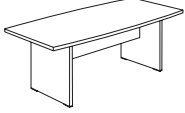

PRS 2200x1000x740



PRO Ø800x550

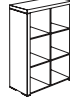

PR3R 900x450x1200



PR3S 900x450x1200



PR3D 900x450x1200

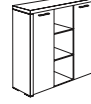

PR3D2/R1 1310x450x1200

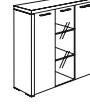

PR3D2/S1 1310x450x1200

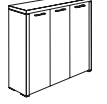

PR3D3 1310x450x1200



PR3D2/R2 1720x450x1200



PR3D2/S2 1720x450x1200

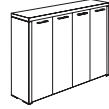

PR3D4 1720x450x1200

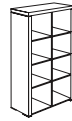

PR5R 900x450x1585

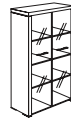

PR5S 900x450x1585



PR5D 900x450x1585

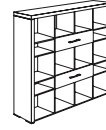

PR5K 1720x450x1585

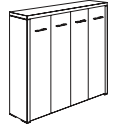

PR5D4 1720x450x1585

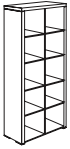

PR6R 900x450x1900

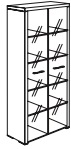

PR6S 900x450x1900



PR6D 900x450x1900

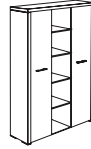

PR6D2/R1 1310x450x1900

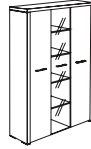

PR6D2/S1 1310x450x1900

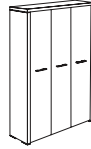

PR6D3 1310x450x1900

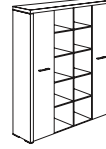

PR6D2/R2 1720x450x1900

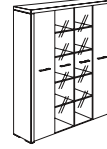

PR6D2/S2 1720x450x1900

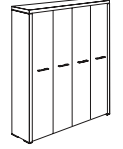

PR6D4 1720x450x1900

POLMARCO

www.polmarco.pl biuro@polmarco.pl